



CERAMIC HEATER

陶瓷暖風機

INSTRUCTION MANUAL

使用說明書

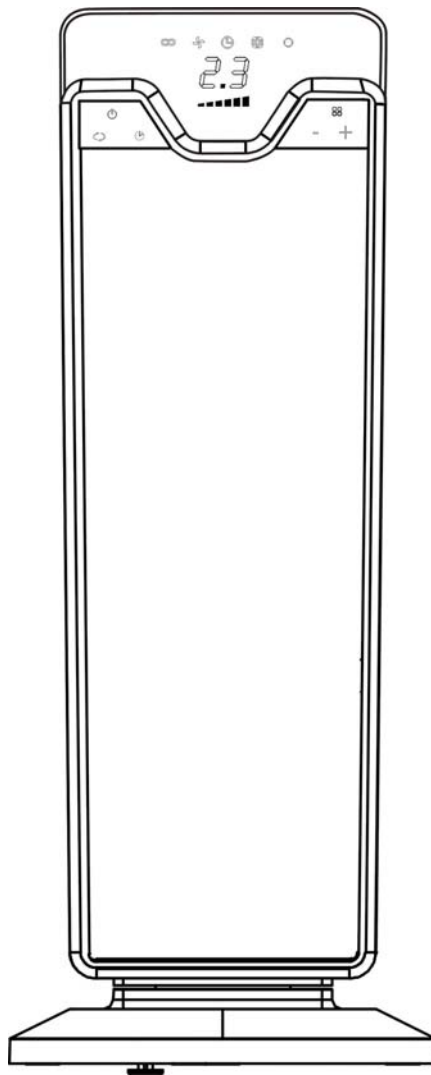

Model No.: RA-CH862S

請閱讀和保存此說明書以供日後參考

Please read and keep this instruction manual for further reference

產品安全指引

1. 8歲以上兒童及生理、感知、心智能力、經驗或知識不足之人士，在接受過關於安全使用本產品的監護或指導、並了解相關危險的情況下，可以使用本產品。
2. 兒童不應嬉玩本產品。
3. 在沒有監護的情況下，不應由兒童獨自進行清潔與保養
4. 除非有持續監護，否則應把3歲以下的兒童遠離本產品。
5. 3歲至8歲以下的兒童只能在產品已經放置或安裝在其預定的正常操作位置，並且接受了安全使用該產品的監督或指導，並了解其危害的情況下，才可以打開/關閉本產品。3歲至8歲以下的兒童不得插入插頭、調節和清潔本產品或對本產品進行維護。
6. 注意-本產品的某些部件會變得很熱，會導致灼傷。當兒童和骸質、感知或心智能力有障礙或是缺乏經驗與知識人士在場時，必須給予特別注意。

產品外觀

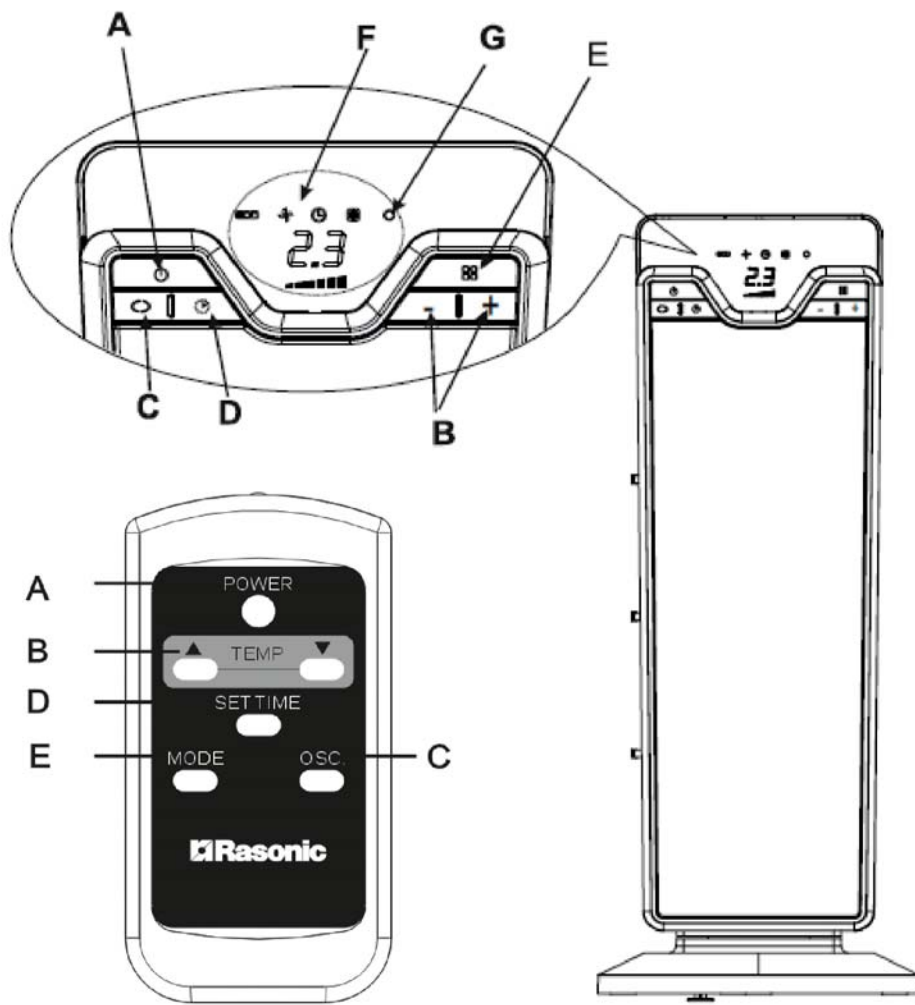

- A. 電源開關按鈕
- B. 溫度調節按鈕
- C. 擺動開關按鈕
- D. 時間掣設定按鈕
- E. 模式設定按鈕
- F. LED顯示屏
- G. 電源指示燈
- H. 過濾網
- I. 後蓋

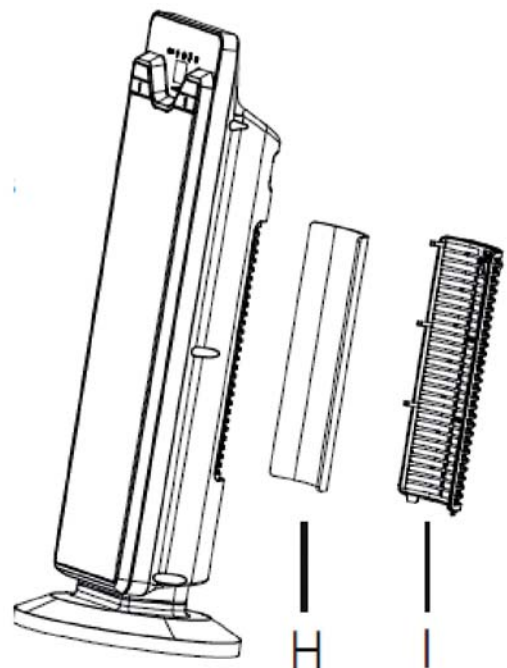











一般安全信息

1. 根據用戶手冊的說明使用本暖風機。任何不符合生產商推薦的使用方法，都可能引起火災、觸電或人身傷害等危險。
2. 確保電力規格，必須符合本暖風機的電源要求。（交流電壓220-240V~，50Hz）
3. 一般電器產品並不是為體質，感覺或智力有障礙人士(包括小孩)，或缺乏經驗及知識者使用，除非他們曾經接受負責安全人士的監督或指示。小心看管小孩，以確保他們不會把此暖風機當作玩具。
4. 為減少觸電的潛在危險，將插頭插在正確的電源插座上。若暖風機的插頭與插座不能完全匹配，應諮詢專業和合資格的技術人員。
5. 每次使用此產品前，確保電源線是完成地鬆開的。如果可以，避免使用延長電源線，因為延長電源線或拖板式插座可能會過熱而導致火災風險。切勿使用單一的延長線運作一個以上的暖風機。另外盡量確保運作暖風機時，在同一插座上不要運作其他的裝置，因為插座可能會負荷過重。
6. 如果暖風機有明顯損壞跡象，切勿使用。
7. 切勿將手指或其它物件，插入進風口或出風口，這樣可能引發觸電或火災等危險，或對暖風機造成損壞。切勿在暖風機操作時，干擾其運作。
8. 為防止火災，切勿以任何方式阻礙進風口與出風口，確保進風與出風格柵完全通暢。切勿將暖風機放在柔軟的物體表面上，例如床上，這可能會堵塞進風口和出風口。
9. 在水平且穩定的表面上使用此暖風機。
10. 暖風機在使用時會很熱。為避免燙傷，切勿讓皮膚接觸燙熱的表面。可使用提手來移動暖風機。
11. 切勿在潮濕的地方、浴缸、企缸或游泳池周圍使用本暖風機。
12. 本暖風機只適合在家居室內使用。
13. 如果暖風機曾掉落，切勿使用。
14.  嚴禁覆蓋！警告：切勿覆蓋暖風機，以免過熱。
15. 切勿將暖風機放在電源插座下。
16. 注意：為了避免危險，不要使用外置的電源開關裝置設備，如定時器或連接到一個電路裝置是定時開關的。
17. 使用時，必須把暖風機放在兒童、動物和殘障人士接觸不到的地方。
18. 切勿在滿佈灰塵或有火警危險的房間內，使用本暖風機。
19. 切勿手濕時觸摸暖風機，以及切勿讓水滲入本暖風機。
20. 警告：除非有人持續看管，否則切勿讓不能自行離開的人士在細小的房間使用此暖風機。
21. 警告：為降低火災風險，將紡織品、窗簾或任何其他易燃物與出風口保持至少1米的距離。
22. 任何電源線的更換應由製造商、其服務代理或類似的具有資格的人員進行。

操作和使用

1. 請將本暖風機連接至獨立電源插座。
2. 本暖風機會發出蜂鳴聲，而電源指示燈 (G) 亦會亮起，直到電源插頭從插座中拔出。

3. 按下開 / 關按鈕 (A)，啟動本暖風機，本暖風機會按照預設功能開始操作。
4. 按下 MODE 按鈕 (E) 選擇下列其中一項功能：
熱風 1 () → 熱風 2 () → 熱風 3 () → ECO → 涼風 () → 防霜 () 。
- 4.1 涼風 () 這模式只有出風功能，不設暖氣運作。
- 4.2 防霜 () 這模式會使室溫維持在45°F [7°C]，以免室溫過份冰冷。
- 4.3 熱風 1 / 熱風 2 / 熱風 3
熱風 1  (弱)
這模式的熱力最弱 (900瓦)，有效減低噪音及省電。
熱風 2  (中)
這模式的熱力為中度 (1500瓦)，快速提高房間溫度。
熱風 3  (強)
這模式的熱力最強 (2200瓦)，以最快速度加熱房間溫度。
- 4.4 ECO 功能只可在熱風 1、熱風 2 和熱風 3 模式中運作。
當此功能啟動時，暖風機會自動調較至最合適的發熱模式，以確保在省電的同時，保持最舒適的室溫。
當ECO功能啟動時，暖風機的發熱功能會自動調校至低於顯示面板的度數。
5. 若想擴大出風範圍，可按擺動按鈕 (C) ()，使暖風機左右擺動。
如要在理想位置停止，可再次按下擺動按鈕。
6. 如要關機，可按下開 / 關按鈕 (A)。關機時，屏幕上會出現約6秒的倒數。

恆溫器的指示

1. 按下 MODE 按鈕 (E) 直至 ECO 模式指示燈亮起。
2. 如要調校溫度，按下 + 及 - 按鈕以調高或降低所須溫度。
3. 當室溫達至預設溫度時，發熱功能將自動停止，並在25秒後停止出風。
4. 當室溫低於預設溫度時，發熱功能將自動重新開始。

注意：

屏幕可顯示華氏及攝氏溫度。如要更改溫標，可在熱風模式下長按機身上 + 按鈕約8秒，再放開手。

請注意此溫度顯示並非精密設備，只供參考之用。顯示溫度可能與真實溫度有少許差別。



為保持設定溫度，暖風機在開、關模式之間循環操作屬正常現象。

調節溫度時，顯示屏上的設定溫度將閃爍5秒。若5秒內仍沒有任何更改，LED燈將停止閃爍，並再次顯示室溫。



24小時數碼時間擊

此功能可在任何操作模式下啟動。

延遲開機：在暖風機關閉狀態下，按下時間擊 (D) 按鈕 ()。

顯示屏出現 () 圖標及開機前的剩餘時間。如要設定延遲開機，請使用 + 和 - (B) 調節按鈕，然後等待程式設置數秒。顯示屏出現 () 圖標，說明您已設定預約開機時間。當到達設定的時間時，暖風機啟動，預設的操作設定將保持不變。

延遲關機：在暖風機開機時，按下時間擊 (D) 按鈕 ()。

顯示屏出現 () 圖標及關機前的剩餘時間。如要設定延遲關機，請使用 + 和 - (B) 調節按鈕，然後等待程式設置數秒。顯示屏重新出現當前的設定及 () 圖標，表示已設定預約關機時間。當到達設定的時間時，暖風機將自動關機。

如想恢復操作並取消時間擊功能，請按時間擊 (D) () 按鈕兩次直至時間擊圖標從顯示屏上消失。

使用遙控器

遙控功能與控制面版功能相似。功能描述詳見前一頁的《操作及使用》部分。

安裝或更換電池

- 取下遙控器背面的蓋子；
- 將鈕扣電池（型號 CR2032/3V）裝入遙控器，正極（平滑面）朝上。
- 重新裝好蓋子。
- 廢舊電池危害環境，必須取出並根據現行法規處理。

安全裝置

1. 此暖風機設有發聲警號以提醒用戶組件過熱。當警號響起時，請立即關掉暖風機，並檢查暖風機上方和周圍有否擺放可能導致過熱的物品。
警號響起時，切勿使用暖風機。
2. 暖風機內置的過熱保護器，可防止過熱情況出現。
3. 當溫度過熱時，暖風機會自動關閉，直至用戶重設暖風機時，才會重新啟動。
(請參照下方的<重設指示>)
4. 當暖風機向任何方向傾倒或被提起時，防傾倒保護裝置會自動中斷電源。防傾倒保護裝置的開關設在暖風機底部。切勿嘗試破壞此安全裝置。

重設指示

1. 拔除暖風機插頭，並等候10分鐘讓它降溫。
2. 10分鐘後，重新接駁插頭，暖風機便會正常運作。

疑難排除

如暖風機突然關掉或停止運作，可能已啟動上述其中一項安全裝置，防止機身過熱。

1. 請確保電源線已接駁到運作正常的插座上。
2. 請檢查恆溫器的設定，暖風機可能因為已超過設定的溫度而關閉。

保養

警告：在移動或維修暖風機前，請必須先拔除電源線。切勿把暖風機浸入水中！

清潔：

每月清潔暖風機至少一次，如果骯髒，請勤加清洗。

請用附有吸塵刷的吸塵機清潔暖風機的進風和出風格柵，這樣能把暖風機內的棉絮和骯髒物從內部徹底清除。

切勿嘗試拆解暖風機。

切勿拿走格柵護罩或在沒有格柵護罩的情況下使用暖風機。

請用柔軟抹布清潔產品機身。（切勿使用研磨劑、酒精或溶劑）

儲存：

不使用暖風機時，請把本說明書和暖風機放進原裝的包裝箱內，並放置在乾爽和陰涼的地方。必須確保暖風機完全降溫後，才把它收藏。

產品規格：

產品型號	RA-CH862S
額定功率	2200W
額定電壓	220-240V~ / 50Hz
淨重	1.92公斤
尺寸	222（闊）x 195（深）x 551（高）毫米

特別聲明

1. 本資料上所有內容經過認真核對，如有任何印刷及內容上的誤解，本公司將保留解釋權。
2. 本產品若有技術改進，會編進新版說明書中，恕不另行通知；產品外觀及顏色如有改動，則以實物為準。
3. 用戶如需要電子版使用說明書，請致電信興電工工程有限公司熱線查詢：2861 2767。

Product Safety instructions

1. This appliance can be used by children aged from 8 years and above and persons with reduced physical, sensory or mental capabilities or lack of experience and knowledge if they have been given supervision or instruction concerning use of the appliance in a safe way and understand the hazards involved.
2. Children shall not play with the appliance.
3. Cleaning and user maintenance shall not be made by children without supervision.
4. Children of less than 3 years should be kept away unless continuously supervised.
5. Children aged from 3 years and less than 8 years shall only switch on/off the appliance provided that it has been placed or installed in its intended normal operating position and they have been given supervision or instruction concerning use of the appliance in a safe way and understand the hazards involved. Children aged from 3 years and less than 8 years shall not plug in, regulate and clean the appliance or perform user maintenance.
6. CAUTION — Some parts of this product can become very hot and cause burns. Particular attention has to be given where children and persons with reduced physical, sensory or mental capabilities or lack of experience and knowledge are present.

Product Appearance

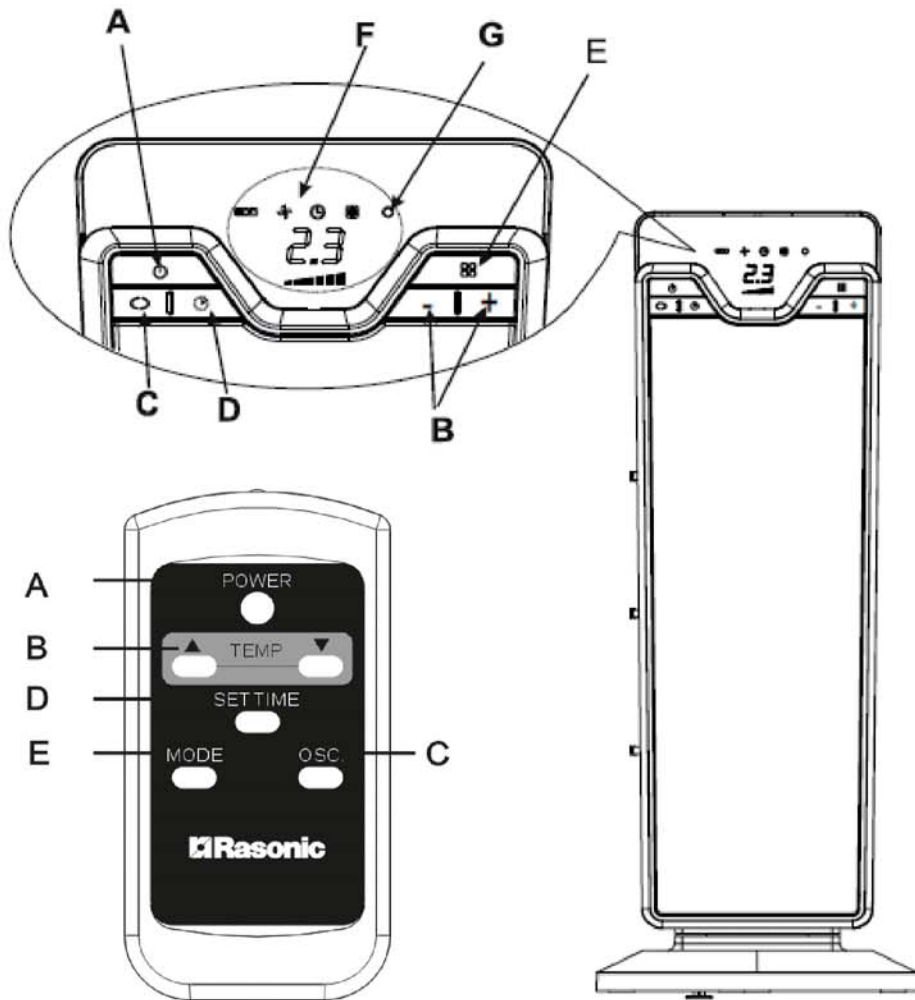

- A. Power on/off button
- B. +/- Adjustment buttons
- C. OSC. on/off button
- D. Timer setting button
- E. Mode setting button
- F. LED Display
- G. Power indicator light
- H. Filter
- I. Back cover

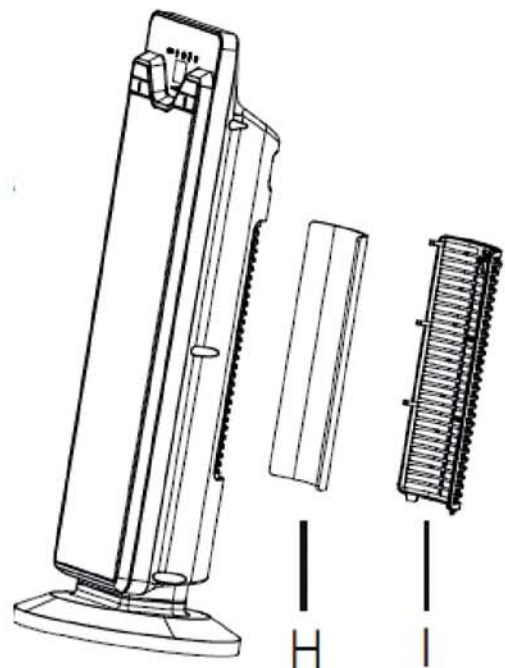

General Safety Information

1. Use this heater only as described in this manual. Any other use not recommended by the manufacturer may cause fire, electrical shock, or injury to persons.
2. Make certain that the power source conforms to the electrical requirements of heater.
(AC220-240V~/50Hz)
3. The appliance is not intended for use by persons (including children) with reduced physical, sensory or mental capabilities, or lack of experience and knowledge, unless they have been given supervision or instruction concerning use of the appliance by a person responsible for their safety; Children should be supervised to ensure that they do not play with the appliance.
4. To reduce the risk of electric shock, this plug is intended to fit in a correct outlet. If the plug of heater does not fit fully in the outlet, please contact a qualified electrician.
5. Fully unwind the lead each time before use. Where possible, avoid using of extension cords because the extension cord may overheat and cause a risk of fire. Never use a single extension cord to operate more than one heater. And make sure no other appliances are plugged into the same circuit with this heater. Otherwise, a circuit overload could occur.
6. Do not use if there are visible signs of damage to the heater.
7. Do not insert or allow fingers or other objects to enter any ventilation or exhaust opening as it may cause an electric shock or fire or damage to the heater. Do not block or tamper with the heater in and manner while it is in operation.
8. To prevent a possible fire, do not block air intakes or exhaust in any manner. Make sure that the air inlet and outlet grills are totally clear. Do not place heater on soft surfaces, like a bed, where openings may become blocked.
9. Use this heater on a horizontal and stable surface.
10. This heater is hot when in use. To avoid burns, do not let bare skin touch hot surfaces. Always use handle when moving this heater.
11. Do not use this heater in the immediate surroundings of a bath, a shower or a swimming pool.
12. The heater is intended for household indoor use only.
13. Do not use this heater if it has been dropped.



14. Do not cover! WARNING: In order to avoid overheating, do not cover the heater.
15. The heater must not be located below a socket- outlet.
16. CAUTION :In order to avoid a hazard due to inadvertent resetting of the thermal cutout, this appliance must not be supplied through an external switching device, such as a timer, or connected to a circuit that is regularly switched on and off by the utility.
17. When in use, this heater must be kept out of the reach of young children, animals and certain handicapped people.
18. Do not use this heater in a dusty room or a room where there is a risk of fire.
19. Do not touch this heater with wet hands. And never allow water to penetrate this heater.
20. WARNING: Do not use this heater in small rooms when they are occupied by persons not capable of leaving the room on their own, unless constant supervision is provided.
21. WARNING : To reduce the risk of fire, keep textiles, curtains, or any other flammable material a minimum distance of 1 m from the air outlet.
22. Any replacement of the supply cord is intended to be made by the manufacturer, its service agent or similar qualified person.

OPERATION AND USE

1. Connect the appliance to the single power outlet.
2. The appliance emits a beep and the power indicator light (G) comes on and remains on as long

as the appliance is powered.

3. Press the ON/OFF button (A) to turn on the appliance. It will begin to heat with the predefined settings.
4. Press the MODE button (E) to select one of the following functions available: Heating 1 (■■) → Heating 2 (■■■) → Heating 3 (■■■■) → ECO → Ventilation (✻) → Anti-freeze (❄).
 - 4.1 Ventilation (✻) Only the fan operates in this mode, so the appliance does not heat the room.
 - 4.2 Anti-freeze (❄) The appliance keeps the room at a temperature of 45°F (7°C) in this mode to prevent freezing temperatures.
 - 4.3 Heating 1, Heating 2 and Heating 3
Heating 1 ■■ (Minimum power)
The appliance operates at the minimum power (900W), reducing noise and energy consumption to the minimum.
Heating 2 ■■■ (Medium power)
The appliance operates at the medium power (1500W) for rapid heating of the room.
Heating 3 ■■■■ (Maximum power)
The appliance operates at the maximum power (2200W) for rapid heating of the room.
 - 4.4 The ECO function is available in Heating 1,2 and 3 modes only.
While the function is active, the appliance automatically sets the most appropriate power level to guarantee optimum comfort while reducing energy consumption.
While the "ECO" function is active, the appliance may switch automatically to a lower heating power than the one displayed.
5. If you want the appliance to distribute the airflow over a larger area, press the oscillation button (C)(↔). The appliance will then oscillate right and left. To stop the oscillation in the desired position, just press oscillation button (C) again.
6. To turn off the appliance, press button ON /OFF (A). The display will show a countdown for about 6 seconds.

THERMOSTAT INSTRUCTIONS

1. Press the MODE button (E) until the Mode indicator light turns on in **ECO** mode.
2. To adjust set temperature, Press the button + to increase the desired temperature and the button - to decrease the desired temperature.
3. When the room temperature reaches the set temperature, the heater will stop to heat at once and stop blowing after 25 seconds.
4. When the room temperature is below the set temperature, the heater will resume.

NOTE:

The display can show the temperature in both °F and °C. To change the temperature scale, press and hold the + key on the machine for 8 seconds in heating mode, then release.

Please be aware that as this display is for information purposes only and not a precision device. The displayed temperature may slightly vary from the actual temperature.

It is normal for the heater to cycle ON and OFF as it maintains the set temperature.

When adjusting temperature, the set temperature on display will flicker for 5 seconds. In 5 seconds, if no changes are made, LED lights will stop flickering and then the display will show the room temperature again.

24-HOUR DIGITAL TIMER

This function is available in all operation modes.

Delayed switch-on: with the appliance is off, press the timer button (D) (🕒).

The display shows the symbol (🕒) and the time left before switching on.

To set the timer, use + and - adjustment buttons (B), then wait for few seconds for program setting. The display shows the symbol (🕒) to indicate that the timer is being set. When the time has been reached, the appliance turns on with the same settings as the preset operation.

Delayed turn-off: with the appliance is on, press the timer button (D) (🕒).

The display shows the symbol (🕒) and the time left before turning off.

To set the timer, use + and – adjustment buttons (B), then wait for few seconds for program setting. The display shows the symbol (🕒) to indicate that the timer is being set. When the time has been reached, the appliance turns off automatically.

If you want to resume the operation without the timer setting, press the timer button (D) (🕒) twice until the timer symbol disappears from the display.

USING THE REMOTE CONTROL

The remote control functions are identical to those on the control panel. See the section "Operation and Use" on the previous page for a description of the functions.

INSERTING OR REPLACING BATTERIES

- Remove the rear cover of the remote control;
- Insert the button battery (model CR2032/3V) into remote control with the positive pole (smooth side) facing up.
- Replace the cover.
- **Old batteries must be removed and disposed of in accordance with current legislation as they are harmful to the environment.**

Safety Features

1. This heater includes an audible alarm to warn that parts of the heater are getting excessively hot. If the alarm sounds, immediately turn off the heater and inspect any objects on or near the heater that may cause high temperature.

DO NOT OPERATE THE HEATER WITH THE ALARM SOUNDING.

2. A thermal overload protector is built-in to prevent overheating.
3. When an overheat temperature is reached, the heater will be automatically shut off. It can only resume operation when the user resets the unit. (See RESET INSTRUCTIONS below)
4. Tip-Over Protection Feature will cut off the power when the unit falls over in any direction or is lift. It is controlled by the Tip-Over Switch at the bottom of the unit. Do not attempt to defeat this safety feature.

Reset instructions

1. Unplug the heater and wait for 10 minutes to cool down.
2. After 10 minutes, plug the unit and operate again.

Troubleshooting tips

If your heater shuts off unexpectedly or fails to operate, one of the safety features may be activated to prevent overheating.

1. Be sure the power cord is plugged into a working electrical outlet.
2. Check your thermostat setting. The heater will shut off when it reached the desired temperature setting.

Maintenance

WARNING: ALWAYS UNPLUG THE CORD BEFORE MOVING OR SERVICING. DO NOT IMMERSER HEATER IN WATER!

CLEANING:

Clean the heater at least once a month, more often if dirty.

Clean the heater air inlet and outlet grills with the vacuum brush attachment on your vacuum cleaner. This will remove lint and dirt from the inside of the heater.

Do not attempt to take the heater apart.

Do not remove grill guard or allow heater to be operated without grill guard in place.

Clean the heater body with a soft cloth. (NEVER USE ABRASIVE / ALCOHOL OR SOLVENTS.)

STORAGE:

When you are not using the heater, store the heater with this instruction booklet in the original carton in a cool, dry place.

It is extremely important that the heater should be cooled down before storage.

Product Specification:

Model No.	RA-CH862S
Rated Power	2200W
Rated Voltage	220-240V~ / 50Hz
Net Weight	1.92kg
Unit Dimensions	222 (W) x 195 (D) x 551 (H) mm

SPECIAL AVOWAL

1. The information above has been checked. Our company reserves the hermeneutic power to any printing errors or misunderstanding on the content.
2. If there are technical improvements on the appliance, the operation manual will be updated without any prior notice. The product appearance and color are subject to the actual appliance.
3. The e-copy of user manual can be sent by e-mail on requested, please call Shun Hing Electric Works & Engineering Co. Ltd. hotline at 2861 2767.

信興電工工程有限公司

SHUN HING ELECTRIC WORKS & ENGINEERING CO., LTD

辦公室: 香港九龍尖沙咀東部麼地道67 號半島中心9樓

OFFICE: 9/F, PENINSULA CENTRE, 67 MODY ROAD, TSIMSHATSUI EAST, KOWLOON,
HONG KONG

電話 TEL: (852) 2861 2767

傳真 FAX: (852) 2865 6706

網址 WEBSITE: www.rasonic.com

電郵 EMAIL: shew@shunhinggroup.com

保養及維修 MAINTENANCE AND REPAIR SERVICE

信興電器服務中心有限公司

SHUN HING ELECTRIC SERVICE CENTRE LTD.

辦公室: 香港新界葵涌勝耀街2號信興中心11樓

OFFICE: 11TH FLOOR, SHUN HING CENTRE, 2 SHING YIU STREET, KWAI CHUNG, NEW
TERRITORIES, HONG KONG

電話 TEL: (852) 2406 5666

傳真 FAX: (852) 2408 0316

網址 WEBSITE: www.shesc.com

消耗品/附件銷售熱線 CONSUMABLES/ ACCESSORIES SALES HOTLINE

電話 TEL: (852) 2406 5666

客戶服務中心 CUSTOMER SERVICE CENTRES

香港新界葵涌勝耀街2號信興中心1樓

1ST FLOOR, SHUN HING CENTRE, 2 SHING YIU STREET, KWAI CHUNG,
NEW TERRITORIES, HONG KONG

電話 TEL: (852) 2406 5439

傳真 FAX: (852) 2408 1389

澳門慕拉士大馬路193-199號南嶺工業大廈5樓I座

AVENIDA DE VENCESLAU DE MORAIS, NO. 193-199, 5 ANDAR-I, EDF.

INDUSTRIAL NAM LENG, MACAU

電話 TEL: (853) 2836 2928

傳真 FAX: (853) 2833 6405

有關最新之客戶服務中心資訊, 請參閱信興服務中心網址: www.shesc.com或致電
維修服務熱線查詢。

For the latest information of customer service centres, please visit www.shesc.com
or call us at our hotline.